



TINYD HOUSES

Tiny House Life



House



Office



Clinic



Cafe



Otel

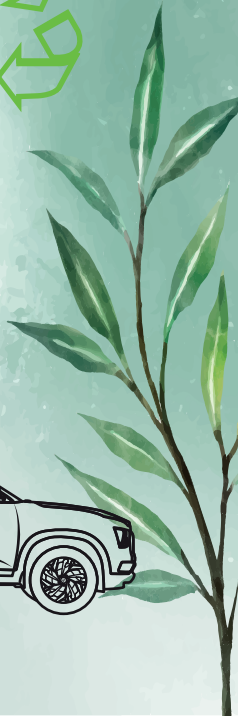



TINYD
HOUSES

TINYD
HOUSES

TÜRKÖĞLÜ

Avantajlar | Advantages



Konfor / Comfort



Mobilite / Mobility

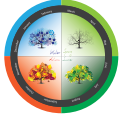

4 Mevsim Kullanım / 4 Seasons Use



Ortak Kullanım / Common usage



Doğa ile Uyum / Harmony with Nature



Mevzuatlara Uyumluluk / Regulatory Compliance

Ayrıcalıklar | Privileges



Servis Hizmeti / Service



Garanti / Guarantee



Stoktan Satış / Stock Sales



Sigorta / Insurance



Standartlara Uyum /
Compliance with Standards



45 Günde Teslimat & Nakliye
/ Delivery & Shipping in 45 Days

TINYD
HOUSES

NE TEKLİF EDİYORUZ / WE OFFER

- DOĞAL KONFOR / NATURAL COMFORT
- SAĞLIKLI YAŞAM / HEALTHY LIFESTYLE



BİZ KİMİZ? WHO ARE WE?



TINY DHOUSES Yapı Sistemleri Sanayi ve Ticaret Ltd. Şti. Türkiye'de uluslararası standartlarda; yapım işleri tarihi; 1990 Yılından itibaren; Türkiye'nin önemli ölçekli tesislerinin inşa tecrübesinin yansıttığı ve nitelikli uzmanları ile güçlenerek kurumsal gerekliliklere sahip güvenilir bir firma yapılanmasıdır.

TINY DHOUSES Kurucuları ve ekibinde yer alan personel; gerçek kişi girişim ve inşa sektörünün prestijli markası Şule Şahan Ltd. Şti. olarak 32 yıllık bir tecrübe birikimi bünyesinde barındırmaktadır.

Baraj, sanayi tesisi, sosyal tesisler, çeşitli ölçek ve kategorilerde konut üretimine müteakiben günün taleplerine uygun olarak doğa ile barışık minimal yaşam tarzına uygun taşınabilir evler sektöründe hızlı ve kaliteli bir gelişim sürecine girmiştir. Bu sürece paralel olarak grup bünyesinde minimal konut üretimi TINY DHOUSES Yapı Sistemleri Sanayi ve Ticaret Ltd. Şti. 2021 yılında kurularak tüzel kişiliğe kavuşturulmuştur.

Yapı ve üretim tekniklerini, mühendislik ve tasarım becerilerini geri dönüşler ve trendler doğrultusunda hızla güncellemekte, müşteri memnuniyetini üst seviyede tutmak için geniş bir arz yelpazesi içinde yer alan malzeme tedarikini sürdürülebilir kaynak ve kaliteli ürün felsefesi çerçevesinde gerçekleştirmektedir.

Founders of TINY DHOUSES Building Systems Industry and Trade Limited Company; They have been carrying out construction works at international standards in Turkey since 1990. Founding team; He reflected his experience of construction in important scale facilities of Turkey to TINY DHOUSES Company. TINY DHOUSES is a reliable company structure with institutional requirements by strengthening with its experts.

TINY DHOUSES, which has become institutional by getting stronger with its experts; its founders and staff members; as Şule Şahan Limited Şirketi, the prestigious brand of the real person enterprise and construction sector, it embodies 32 years of experience.

Founding team made the production of barrage, industrial buildings, social buildings, housing in various scales and categories. In the ongoing process, in accordance with the demands of the day; It has entered a rapid and high-quality development process in the sector of portable houses that are in harmony with nature, suitable for minimal lifestyle.

In parallel with this process; TINY DHOUSES Building Systems Industry and Trade Limited Company was established in 2021 as a separate company to produce minimal housing within the group.

Company; rapidly updates its construction and production techniques, engineering and design skills in line with the feedbacks and trends. In order to keep customer satisfaction at the highest level, it supplies materials within a wide supply range within the framework of sustainable source and quality product philosophy.

Modeller / Models

Mooble House ürünleri plakalı ve ruhsatlı araçlardır. Bu sebeple karayolları kanunlarına uygun standartlarda üretilmektedirler. /
Mooble House products are vehicles with license plates and licenses. For this reason, they are produced in accordance with the standards of highway laws.

Temiz Su ve Atık Su Altyapı Sistemi /
Clean Water and Waste Water Infrastructure System
İklimlendirme Altyapısı / Air Conditioning Infrastructure
Hermetik Broyler Altyapısı / Hermetic Water Heater Infrastructure

Model Ölçü Aralıkları / Model Size Ranges

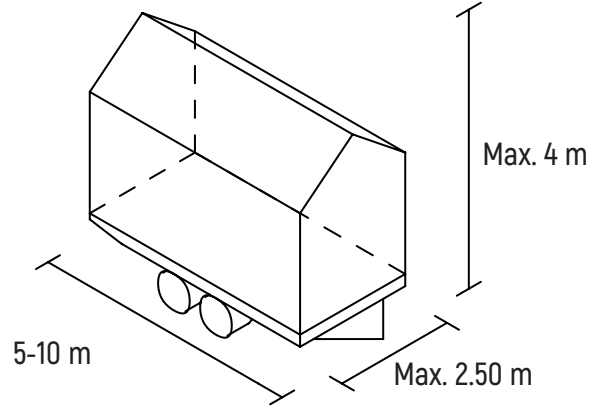

+

Max. 3500 kg

TINYD
HOUSES

Model Değişken Tablosu / Model Variable Table

	TD.5 ^{5.5} Tiny House	TD.6 ^{6.5} Tiny House	TD.7 ^{7.5} Tiny House	TD.8 ^{8.5} Tiny House	TD.9 ^{9.5} Tiny House	TD.10 Tiny House	TC.8 Tiny Otel- Office	TK.5 Tiny Clinic
Asma Kat / Loft	+	+	+	+	+	+	-	-
Metal ve Ahşap Karma Cephe / Metal and Wood Mixed Facade	+	+	+	+	+	+	+	+
Cam Cephe / Glass Facade	-	-	-	-	-	-	+	-
Panel Cephe / Panel Facade	-	-	-	-	-	-	-	+
Kapasite / Capacity	2-3	3-4	3-4	4-6	4-6	4-6		

Mekanik Ekipman / Mechanical Equipment

Klozet
Lavoba Ve Batarya Ve Duş Bataryaları
Duş Teknesi
Temperli Cam Duşa Kabin
Mutfak Evyesi Ve Alt Yapıları
Ankastre Ocak
Mekanik Tesisat Sistemi
Temiz Su Ve Pis Su Alt Yapı Sistemi
Hermetik Termosifon Alt Yapısı
Klima Alt Yapısı

Toilet Bowl
Sink And Mixer And Shower Faucets
Shower Tray
Tempered Glass Shower Cabin
Kitchen Sink And Infrastructures
Built-in Cooker
Mechanical Installation System
Clean Water and Waste Water
Infrastructure System
Hermetic Water Heater Infrastructure
Air Conditioning Infrastructure

Elektrik Donanımı / Electrical Equipment

Yangın Geçirmez Kablo İle Döşenmiş
Elektirik Tesisatı
220W, Anahtar Ve Priz Montajı
1. Sınıf Led Ve Spot Tavan Aydınlatma
1. Sınıf Dış Aydınlatma Aplikleri
Dış Mekan Elektirik Alt Yapısı
Solar Enerji Alt Yapısı
Tv Uydu Alt Yapısı
Solar Enerji Paneli

Fire resist electrical infrastructure
included, with 220V outlets and
switches
Led and spot lighting fixtures for
inside
Wall mounted water-resist lighting
fixtures for outside
Exterior lighting infrastructure
included
Solar energy infrastructure included
Tv and satellite infrastructure
included

Opsiyonel Donanımlar / Optional Equipment

Koltuk Takımı, Sandalye ve Masa
1.50 – 1.60 * 1.90 Yatak
Perde Seti
Kapı Ve Pencere Sineklik Ve Panjur
Temiz Su Ve Pis Su Deposu
Ön Tarafa Teras Deck
Bluetooth Usb Panel
Hopartlör Müzik Sistemi
Tezgah Üstü Gizli Priz
Klima
Kalorifer Ve Elektirikli Panel
Hermetik Şofben
Elektirikli Termosifon
Elektirikli Yerden Isıtma Sistemi
Buzdolabı, Çamaşır Makinası, Bulaşık
Makinası, Televizyon

Sofa Set, Chair and Table
1.50 – 1.60 * 1.90 Bed
Curtain Set
Door And Window Insect Screen And
Blinds
Clean Water And Waste Water Tank
Front Terrace Deck
Bluetooth Usb Panel
Speaker Music System
Counter Top Concealed Socket
Air conditioning
Heating And Electric Panel
Hermetic Geyser
Electric Water Heater
Electric Underfloor Heating System
Refrigerator, Washing Machine,
Dishwasher, Television



Uzunluk / Length: 5 & 5.5 m

Geniřlik / Width: 2.50 m

Kiři kapasitesi / Person capacity 2-3

Genel Özellikler

Şase dahil toplam 4 metre yükseklikte, hafif çelik iskeletten inşa edilmiş, sorunsuz ısı ve su yalıtımına sahip, kapı ve pencereler ısı yalıtımlı kaliteli alüminyum veya pen malzemeden, zemin derzli laminat parke, çatıda ısı yalıtımı ve taş yünü, dış cephe fırınlanmış ithal çam ve kompozit kaplama.

Yaşam ve uyku alanlarının tek bir hacimde ergonomik bir asma kat ile birleřtiđi bu model 5 metre uzunluđunda ve 2-3 kiřinin kullanımına uygun.



MODEL
TD5

General Specification

A total of 4 meters high including the chassis, built of light steel skeleton, with seamless heat and water insulation, doors and windows made of heat-insulated quality aluminum or pvc material, laminate flooring with floor joints, Special kenet sheet roof covering and rock wool for thermal insulation, exterior kiln-dried imported pine and composite coating .

This model, which combines living and sleeping areas with an ergonomic mezzanine in a single volume, is 5 meters long and can be used by 2-3 people.suitable.

TD 5 Tiny House

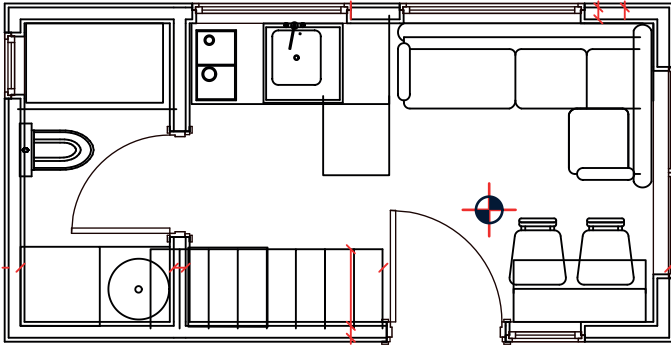

Zemin Kat / Ground floor

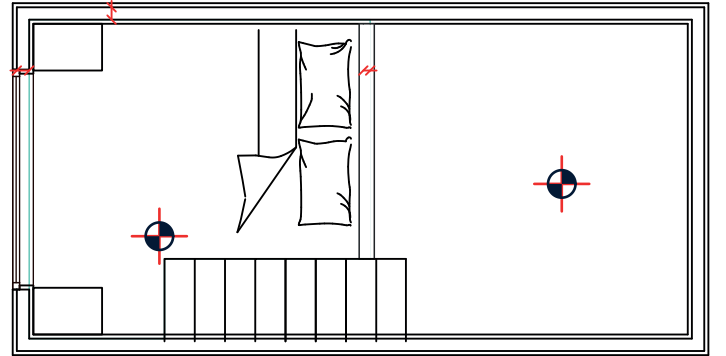

Loft

Uzunluk / Length: 6 & 6.5 m
Geniřlik / Width: 2.50 m
Kiři kapasitesi / Person capacity 3-4

Genel Özellikler

Şase dahil toplam 4 metre yükseklikte, hafif çelik iskeletten inşa edilmiş, sorunsuz ısı ve su yalıtımına sahip, kapı ve pencereler ısı yalıtımlı kaliteli alüminyum veya pen malzemeden, zemin derzli laminat parke, çatıda ısı yalıtımı ve taş yünü, dış cephe fırınlanmış ithal çam ve kompozit kaplama. Yaşam ve uyku alanlarının tek bir hacimde ergonomik bir asma kat ile birleştiği bu model 6 metre uzunluğunda ve 3-4 kişinin kullanımına uygun.



TD 6 Tiny House

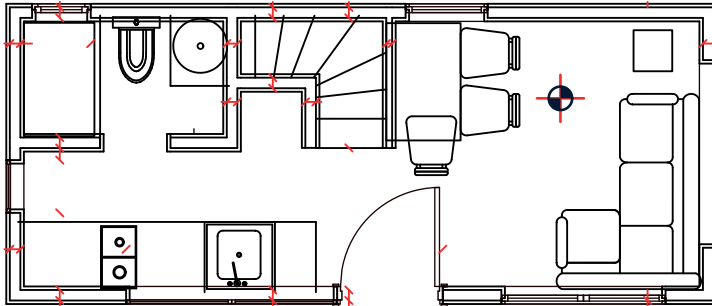

Zemin Kat / Ground floor

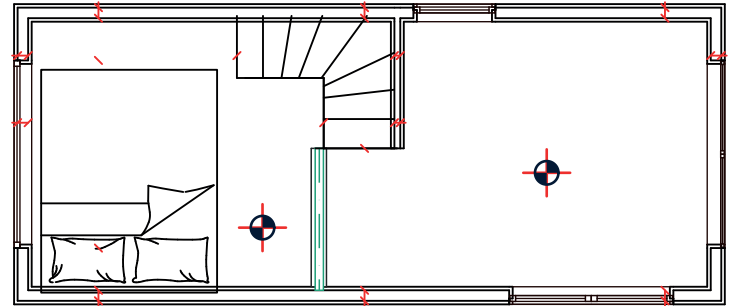

Loft



MODEL
TD6

General Specification

A total of 4 meters high including the chassis, built of light steel skeleton, with seamless heat and water insulation, doors and windows made of heat-insulated quality aluminum or pvc material, laminate flooring with floor joints, Special kenet sheet roof covering and rock wool for thermal insulation, exterior kiln-dried imported pine and composite coating . This model, which combines living and sleeping areas with an ergonomic mezzanine in a single volume, is 6 meters long and can be used by 3-4 people.suitable.

Uzunluk / Length: 7 & 7.5 m

Geniřlik / Width: 2.50 m

Kiři kapasitesi / Person capacity 3-4

Genel Özellikler

řase dahil toplam 4 metre yükseklikte, hafif elik iskeletten inřa edilmiř, sorunsuz ısı ve su yalıtımına sahip, kapı ve pencereler ısı yalıtımlı kaliteli alüminyum veya pen malzemeden, zemin derzli laminat parke, atıda ısı yalıtımı ve tař yünü, diř cephe fırınlanmış ithal am ve kompozit kaplama.

Yařam ve uyku alanlarının tek bir hacimde ergonomik bir asma kat ile birleřtięi bu model 7 metre uzunluęunda ve 3-4 kiřinin kullanımına uygun.



MODEL
TD7

General Specification

A total of 4 meters high including the chassis, built of light steel skeleton, with seamless heat and water insulation, doors and windows made of heat-insulated quality aluminum or pvc material, laminate flooring with floor joints, Special kenet sheet roof covering and rock wool for thermal insulation, exterior kiln-dried imported pine and composite coating . This model, which combines living and sleeping areas with an ergonomic mezzanine in a single volume, is 7 meters long and can be used by 3-4 people.suitable.



TD 7 Tiny House

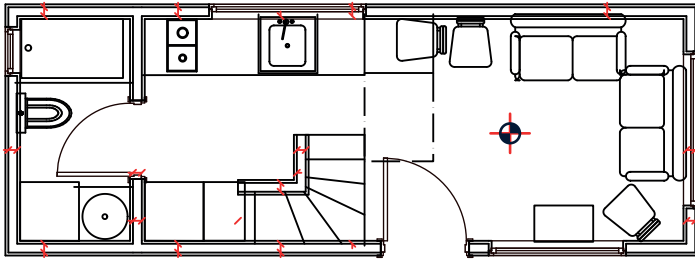

Zemin Kat / Ground floor

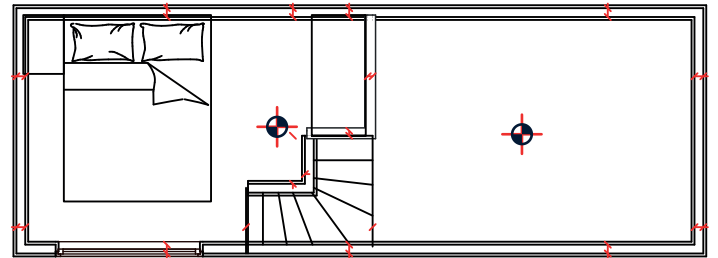

Loft

Uzunluk / Length: 8 & 8.5 m
Geniřlik / Width: 2.50 m
Kiři kapasitesi / Person capacity 4-6

Genel Özellikler

Şase dahil toplam 4 metre yükseklikte, hafif çelik iskeletten inşa edilmiş, sorunsuz ısı ve su yalıtımına sahip, kapı ve pencereler ısı yalıtımlı kaliteli alüminyum veya pen malzemeden, zemin derzli laminat parke, çatıda ısı yalıtımı ve taş yünü, dış cephe fırınlanmış ithal çam ve kompozit kaplama. Yaşam ve uyku alanlarının tek bir hacimde ergonomik bir asma kat ile birleştiği bu model 8 metre uzunluğunda ve 4-6 kişinin kullanımına uygun.



**MODEL
TD8**

General Specification

A total of 4 meters high including the chassis, built of light steel skeleton, with seamless heat and water insulation, doors and windows made of heat-insulated quality aluminum or pvc material, laminate flooring with floor joints, Special kenet sheet roof covering and rock wool for thermal insulation, exterior kiln-dried imported pine and composite coating . This model, which combines living and sleeping areas with an ergonomic mezzanine in a single volume, is 8 meters long and can be used by 4-6 people.suitable.

TD 8 Tiny House

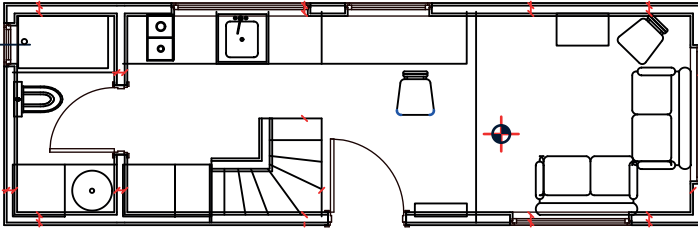

Zemin Kat / Ground floor

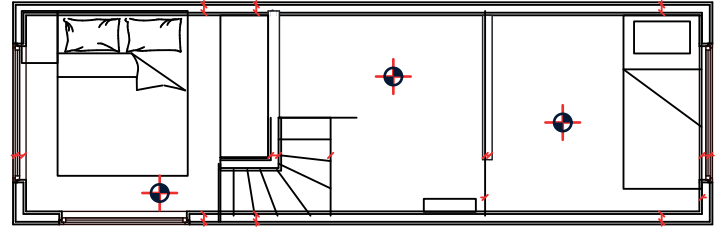

Loft

Uzunluk / Length: 9 & 9.5 m
Genişlik / Width: 2.50 m
Kişi kapasitesi / Person capacity 4-6

MODEL TD9

Genel Özellikler

Şase dahil toplam 4 metre yükseklikte, hafif çelik iskeletten inşa edilmiş, sorunsuz ısı ve su yalıtımına sahip, kapı ve pencereler ısı yalıtımlı kaliteli alüminyum veya pen malzemeden, zemin derzli laminat parke, çatıda ısı yalıtımı ve taş yünü, dış cephe fırınlanmış ithal çam ve kompozit kaplama. Yaşam ve uyku alanlarının tek bir hacimde ergonomik bir asma kat ile birleştiği bu model 9 metre uzunluğunda ve 4-6 kişinin kullanımına uygun.



General Specification

A total of 4 meters high including the chassis, built of light steel skeleton, with seamless heat and water insulation, doors and windows made of heat-insulated quality aluminum or pvc material, laminate flooring with floor joints, Special kenet sheet roof covering and rock wool for thermal insulation, exterior kiln-dried imported pine and composite coating . This model, which combines living and sleeping areas with an ergonomic mezzanine in a single volume, is 9 meters long and can be used by 4-6 people.suitable.

TD 9 Tiny House

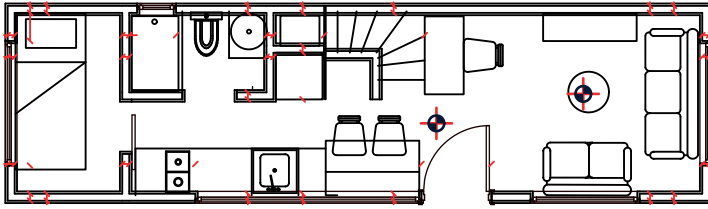

Zemin Kat / Ground floor

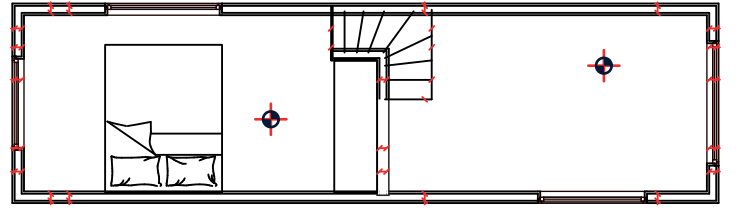

Loft

Uzunluk / Length: 10 m
Genişlik / Width: 2.50 m
Kişi kapasitesi / Person capacity 4-6

Genel Özellikler

Şase dahil toplam 4 metre yükseklikte, hafif çelik iskeletten inşa edilmiş, sorunsuz ısı ve su yalıtımına sahip, kapı ve pencereler ısı yalıtımlı kaliteli alüminyum veya pen malzemeden, zemin derzli laminat parke, çatıda ısı yalıtımı ve taş yünü, dış cephe fırınlanmış ithal çam ve kompozit kaplama. Yaşam ve uyku alanlarının tek bir hacimde ergonomik bir asma kat ile birleştiği bu model 10 metre uzunluğunda ve 4-6 kişinin kullanımına uygun.



**MODEL
TD10**

General Specification

A total of 4 meters high including the chassis, built of light steel skeleton, with seamless heat and water insulation, doors and windows made of heat-insulated quality aluminum or pvc material, laminate flooring with floor joints, Special kenet sheet roof covering and rock wool for thermal insulation, exterior kiln-dried imported pine and composite coating .

This model, which combines living and sleeping areas with an ergonomic mezzanine in a single volume, is 10 meters long and can be used by 4-6 people.suitable.

TD 10 Tiny House

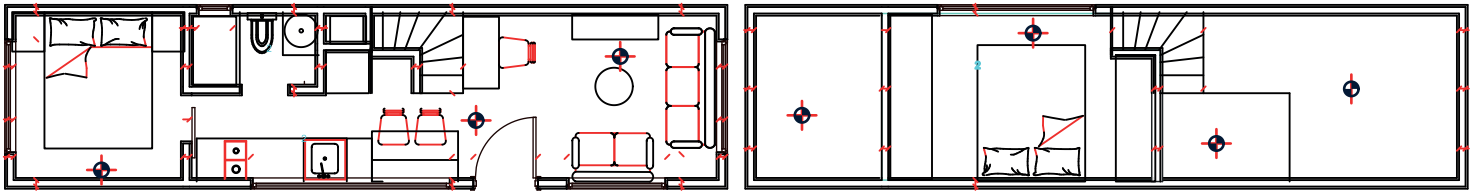

Zemin Kat / Ground floor

Loft

Uzunluk / Length: 8 m
Geniřlik / Width: 2.50 m

Genel Özellikler

Şase dahil toplam 4 metre yükseklikte, kutu profil iskeletten inşa edilmiş, sorunsuz ısı ve su yalıtımına sahip, kapı ve pencereler ısı yalıtımlı kaliteli malzemeden imal edilmiş, zemin derzli parke, çatıda sandwich panel, ön cephe ve bir yan cephede tamamen ısı yalıtımlı cam giydirme, oteller ve ofis olarak tasarlanmış bir modeldir. Dış cephe tercihe göre kenet sac ve emprenye edilmiş ağaçtan da imal edilmektedir.

Yaşam ve uyku alanlarının tek bir hacimde birleştiği bu model 8 metre uzunluğundadır.

Otel ve Ofis , Cam ve Ağaç
Cephe Seçenekleri Alternatifi /
Hotel and Office, Glass and Wood
Facade Options Alternatives

**MODEL
TC8**

TC8 Tiny Otel /
Office

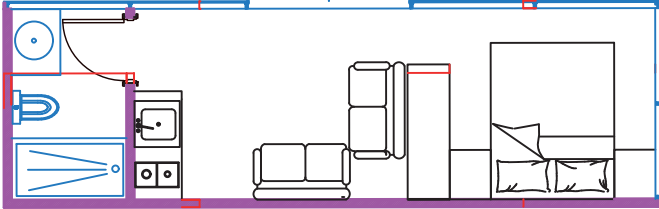

General Specification

A total of 4 meters high including the chassis, built of box profile skeleton, with seamless heat and water insulation, doors and windows made of heat-insulated quality material, it is a model designed for hotels and offices with parquet floor with joints, sandwich panel on the roof, fully insulated glass cladding on the front facade and one side facades. The exterior facade is also manufactured from clamp sheet and impregnated wood according to preference.

Combining living and sleeping areas in a single volume, this model is 8 meters long

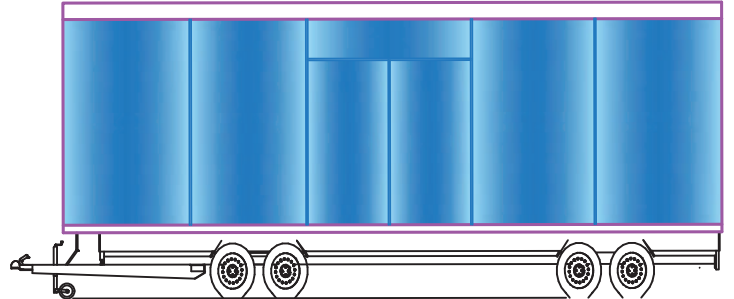

Uzunluk / Length: 5-6-7 m
Geniřlik / Width: 2.50 m

Genel Özellikler

řase dahil toplam 4 metre yükseklikte, hafif elik iskeletten inřa edilmiř, sorunsuz ısı ve su yalıtımına sahip, kapı ve pencereler ısı yalıtımlı pvc malzemeden imal edilmiř olup, zemin antibakteriyal pvc, kompozit dıř cephe, MDF dolaplar ve masa, mutfak paslanmaz elik gvde, lavoba fotoselli musluk, temiz su, pis su tankı, jenaratr, gneř paneli, yangın tp, klima.

5-6-7 metre uzunluk seeneklerinde klinik hizmeti vermek zere tasarlanmıř bir modeldir.

**MODEL
TK5**



General Specification

A total height of 4 meters including the chassis, built of light steel frame, with trouble-free heat and water insulation, doors and windows are made of heat insulated pvc material, floor antibacterial pvc, composite exterior, MDF cabinets and table, kitchen stainless steel body, sink photocell faucet, clean water, waste water tank, generator, solar panel, fire tube, air conditioning.

It is a model designed to provide clinical service in 5-6-7 meter length options.





TINY D
HOUSES

www.tinydhouses.com

info@tinydhouses.com

+90 266 243 60 41

Merkez / Head Office

Altıeylül Mahallesi Çiğdem Sokak Bayar Apartmanı

No:1 Kat:4 Altıeylül BALIKESİR / TÜRKİYE

Üretim / Production Site

Atatepe Sanayi Sistesı BALIKESİR / TÜRKİYE

TINYD
HOUSES

